

YOUR  
OWN  
STYLE

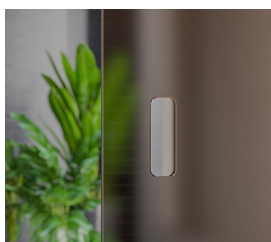

# WALK IN COULISSANTE

Sliding door.



H200

6mm

8mm

## Finiture / Finishes / Acabados / Finitions / Afwerkingen / Ausführungen

Telaio / Frame / Bastidor / Profilé / Frame / Rahmen

Vetro / Glass / Vidrio / Verre / Glas / Glas

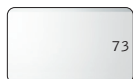
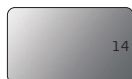
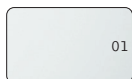
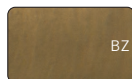
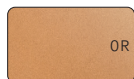
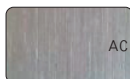

## Modelli / Models / Modelos / Modèles / Modellen / Modelle

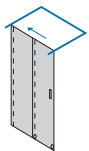
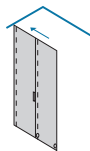
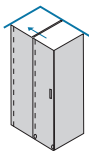

www.inda.net

 **inda**<sup>®</sup>  
bathroom interiors



WALK IN\_COULISSANTE

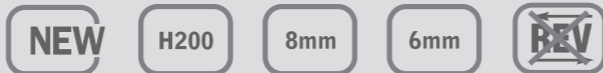

Walk-in scorrevole sinistra / Walk-in left sliding door  
Walk-in coulissante gauche / Walk-in corredera izquierda  
Linker schuifdeur / Linke Schiebetür

H max 217 cm  
L min 50 cm max 190 cm



Le dimensioni sono in mm / Sizes in mm /  
Les dimensions sont indiquées en mm /  
Las medidas son en mm /  
De afmetingen zijn vermeld in mm / Maßangaben in mm

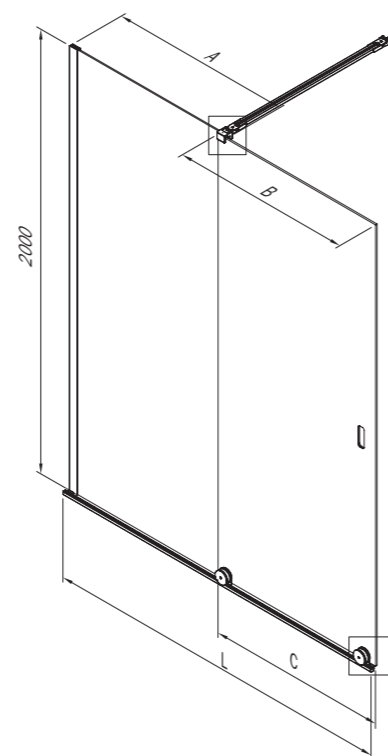
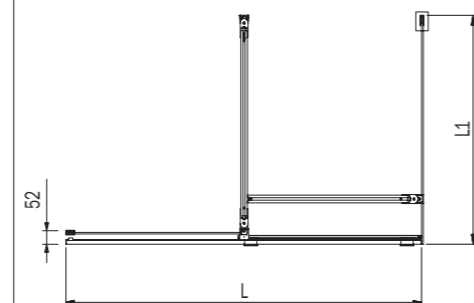

Porta scorrevole 8 mm, parete fissa 6 mm, maniglia M3.  
8mm sliding door, 6mm fixed panel, M3 handle.  
Porte coulissante 8 mm, panneau fixe 6 mm, poignée M3.  
Puerta corredera de 8 mm, panel fijo de 6 mm, tirador M3.  
8 mm schuifdeur, 6 mm vaste wand, M3 handvat.  
Schiebetür 8mm, Feste Wand 6 mm, Griff M3.

L	A	B	C	KG	
98 - 100	52,3	51,7	46	50	2
100 - 110	57,3	56,7	51	55	2
110 - 120	62,3	61,7	56	60	2
120 - 140	72,3	71,7	66	67	2
140 - 160	82,3	81,7	76	76	2
160 - 180	92,3	91,7	86	84	2
<b>L1 PARETE FISSA / FIXED PANEL</b>					
68 - 70				36	1
78 - 80				41	1
88 - 90				46	1
98 - 100				50	1

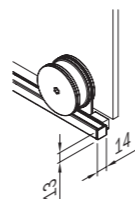
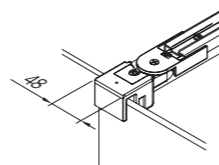

AN WM BM AC OR BZ	01	14	73	41
Larghezza - estensibilità Breadth - extensibility Largeur - extensibilité Composición - extensibilidad Breedte - aanpassingsvermogen Breite - Anpassungsfähigkeit	cod.	cod.	cod.	cod.
<b>L 98 - 100 cm</b>	B2520 0 AN 01	B2520 0 AN 14	B2520 S AN 73	B2520 S AN 41
WM - BM	B2520 0 ..... 01	B2520 0 ..... 14	B2520 S ..... 73	B2520 S ..... 41
AC - OR - BZ	B2520 0 ..... 01	B2520 0 ..... 14	B2520 S ..... 73	B2520 S ..... 41
<b>L 100 - 110 cm</b>	B2521 0 AN 01	B2521 0 AN 14	B2521 S AN 73	B2521 S AN 41
WM - BM	B2521 0 ..... 01	B2521 0 ..... 14	B2521 S ..... 73	B2521 S ..... 41
AC - OR - BZ	B2521 0 ..... 01	B2521 0 ..... 14	B2521 S ..... 73	B2521 S ..... 41
<b>L 110 - 120 cm</b>	B2522 0 AN 01	B2522 0 AN 14	B2522 S AN 73	B2522 S AN 41
WM - BM	B2522 0 ..... 01	B2522 0 ..... 14	B2522 S ..... 73	B2522 S ..... 41
AC - OR - BZ	B2522 0 ..... 01	B2522 0 ..... 14	B2522 S ..... 73	B2522 S ..... 41
<b>L 120 - 140 cm</b>	B2523 0 AN 01	B2523 0 AN 14	B2523 S AN 73	B2523 S AN 41
WM - BM	B2523 0 ..... 01	B2523 0 ..... 14	B2523 S ..... 73	B2523 S ..... 41
AC - OR - BZ	B2523 0 ..... 01	B2523 0 ..... 14	B2523 S ..... 73	B2523 S ..... 41
<b>L 140 - 160 cm</b>	B2524 0 AN 01	B2524 0 AN 14	B2524 S AN 73	B2524 S AN 41
WM - BM	B2524 0 ..... 01	B2524 0 ..... 14	B2524 S ..... 73	B2524 S ..... 41
AC - OR - BZ	B2524 0 ..... 01	B2524 0 ..... 14	B2524 S ..... 73	B2524 S ..... 41
<b>L 160 - 180 cm</b>	B2525 0 AN 01	B2525 0 AN 14	B2525 S AN 73	B2525 S AN 41
WM - BM	B2525 0 ..... 01	B2525 0 ..... 14	B2525 S ..... 73	B2525 S ..... 41
AC - OR - BZ	B2525 0 ..... 01	B2525 0 ..... 14	B2525 S ..... 73	B2525 S ..... 41

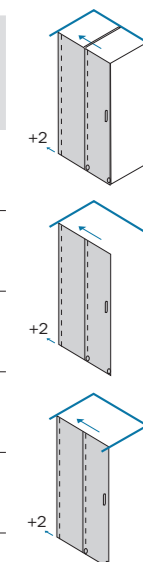

Parete fissa per combinazione ad angolo / Fixed panel for angle combination  
Paroi fixe pour combinaison en angle / Pared fija para combinación de esquina  
Vaste wand voor hoekcombinaties / Feste Wand für Kombinationen

H max 217 cm  
L min 30 cm max 110 cm

Larghezza - estensibilità Breadth - extensibility Largeur - extensibilité Composición - extensibilidad Breedte - aanpassingsvermogen Breite - Anpassungsfähigkeit	cod.	cod.	cod.	cod.
<b>L 68 - 70 cm</b>	B2590 F AN 01	B2590 F AN 14	B2590 F AN 73	B2590 F AN 41
WM - BM	B2590 F ..... 01	B2590 F ..... 14	B2590 F ..... 73	B2590 F ..... 41
AC - OR - BZ	B2590 F ..... 01	B2590 F ..... 14	B2590 F ..... 73	B2590 F ..... 41
<b>L 78 - 80 cm</b>	B2591 F AN 01	B2591 F AN 14	B2591 F AN 73	B2591 F AN 41
WM - BM	B2591 F ..... 01	B2591 F ..... 14	B2591 F ..... 73	B2591 F ..... 41
AC - OR - BZ	B2591 F ..... 01	B2591 F ..... 14	B2591 F ..... 73	B2591 F ..... 41
<b>L 88 - 90 cm</b>	B2592 F AN 01	B2592 F AN 14	B2592 F AN 73	B2592 F AN 41
WM - BM	B2592 F ..... 01	B2592 F ..... 14	B2592 F ..... 73	B2592 F ..... 41
AC - OR - BZ	B2592 F ..... 01	B2592 F ..... 14	B2592 F ..... 73	B2592 F ..... 41
<b>L 98 - 100 cm</b>	B2593 F AN 01	B2593 F AN 14	B2593 F AN 73	B2593 F AN 41
WM - BM	B2593 F ..... 01	B2593 F ..... 14	B2593 F ..... 73	B2593 F ..... 41
AC - OR - BZ	B2593 F ..... 01	B2593 F ..... 14	B2593 F ..... 73	B2593 F ..... 41

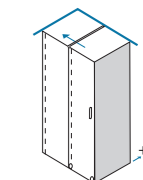

Maniglie  
Handles  
Poignées  
Tiradores  
Handvat  
Griff

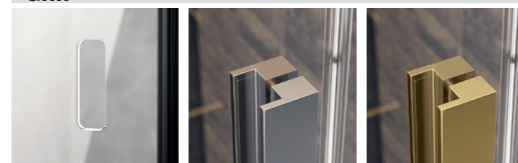

STANDARD M3 ... AN BM WM M3 ... AC OR BZ

Barra  
Bar  
Barre  
Barra  
Staaif  
Leiste



B0080A AN BM WM AC OR BZ BKT251 CR BM WM AC OR BZ BKT252 CR BM WM AC OR BZ

Kit chiusura magnetica  
Magnetic closure kit  
Kit de fermeture magnétique  
Kit de cierre magnético  
Magnetische sluitingskit  
Magnetverschluss Set



B0081 CR BM WM AC OR BZ



WALK IN\_COULISSANTE

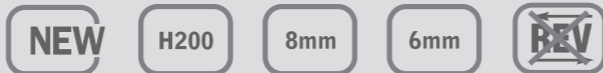

Walk-in scorrevole destra / Walk-in right sliding door  
Walk-in coulissante droite / Walk-in puerta corredera derecha  
Rechter schuifdeur / Rechte Drehtür

H max 217 cm  
L min 50 cm max 190 cm



Le dimensioni sono in mm / Sizes in mm /  
Les dimensions sont indiquées en mm /  
Las medidas son en mm /  
De afmetingen zijn vermeld in mm / Maßangaben in mm

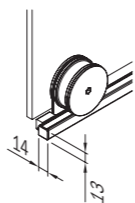
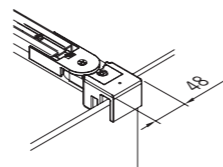
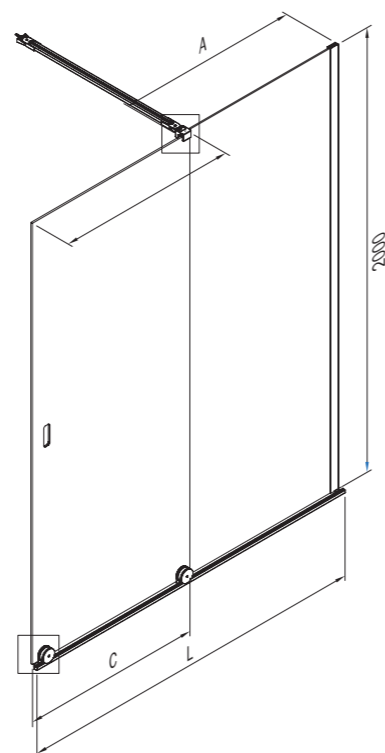
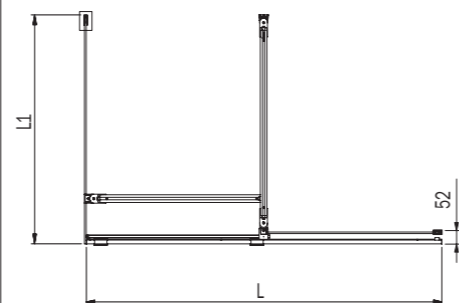

Porta scorrevole 8 mm, parete fissa 6 mm, maniglia standard.  
8mm sliding door, 6mm fixed panel, standard handle.  
Porte coulissante 8 mm, panneau fixe 6 mm, poignée standard.  
Puerta corredera de 8 mm, panel fijo de 6 mm, tirador estándar.  
8 mm schuifdeur, 6 mm vaste wand, standaard handvat.  
Puerta corredera de 8 mm, panel fijo de 6 mm, tirador estándar.

L	A	B	C	KG	
98 - 100	52,3	51,7	46	50	2
100 - 110	57,3	56,7	51	55	2
110 - 120	62,3	61,7	56	60	2
120 - 140	72,3	71,7	66	67	2
140 - 160	82,3	81,7	76	76	2
160 - 180	92,3	91,7	86	84	2
<b>L1 PARETE FISSA / FIXED PANEL</b>					
68 - 70				36	1
78 - 80				41	1
88 - 90				46	1
98 - 100				50	1



AN WM BM AC OR BZ	01	14	73	41
Larghezza - estensibilità Breadth - extensibility Largeur - extensibilité Composición - extensibilidad Breedte - aanpassingsvermogen Breite - Anpassungsfähigkeit	cod.	cod.	cod.	cod.
<b>L 98 - 100 cm</b>	B2520 0 AN 01	B2520 0 AN 14	B2520 D AN 73	B2520 D AN 41
WM - BM	B2520 0 ..... 01	B2520 0 ..... 14	B2520 D ..... 73	B2520 D ..... 41
AC - OR - BZ	B2520 0 ..... 01	B2520 0 ..... 14	B2520 D ..... 73	B2520 D ..... 41
<b>L 100 - 110 cm</b>	B2521 0 AN 01	B2521 0 AN 14	B2521 D AN 73	B2521 D AN 41
WM - BM	B2521 0 ..... 01	B2521 0 ..... 14	B2521 D ..... 73	B2521 D ..... 41
AC - OR - BZ	B2521 0 ..... 01	B2521 0 ..... 14	B2521 D ..... 73	B2521 D ..... 41
<b>L 110 - 120 cm</b>	B2522 0 AN 01	B2522 0 AN 14	B2522 D AN 73	B2522 D AN 41
WM - BM	B2522 0 ..... 01	B2522 0 ..... 14	B2522 D ..... 73	B2522 D ..... 41
AC - OR - BZ	B2522 0 ..... 01	B2522 0 ..... 14	B2522 D ..... 73	B2522 D ..... 41
<b>L 120 - 140 cm</b>	B2523 0 AN 01	B2523 0 AN 14	B2523 D AN 73	B2523 D AN 41
WM - BM	B2523 0 ..... 01	B2523 0 ..... 14	B2523 D ..... 73	B2523 D ..... 41
AC - OR - BZ	B2523 0 ..... 01	B2523 0 ..... 14	B2523 D ..... 73	B2523 D ..... 41
<b>L 140 - 160 cm</b>	B2524 0 AN 01	B2524 0 AN 14	B2524 D AN 73	B2524 D AN 41
WM - BM	B2524 0 ..... 01	B2524 0 ..... 14	B2524 D ..... 73	B2524 D ..... 41
AC - OR - BZ	B2524 0 ..... 01	B2524 0 ..... 14	B2524 D ..... 73	B2524 D ..... 41
<b>L 160 - 180 cm</b>	B2525 0 AN 01	B2525 0 AN 14	B2525 D AN 73	B2525 D AN 41
WM - BM	B2525 0 ..... 01	B2525 0 ..... 14	B2525 D ..... 73	B2525 D ..... 41
AC - OR - BZ	B2525 0 ..... 01	B2525 0 ..... 14	B2525 D ..... 73	B2525 D ..... 41

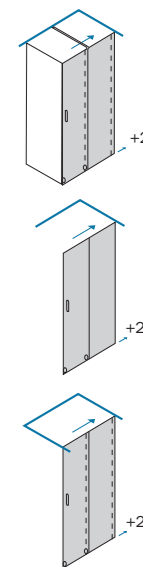

Parete fissa per combinazione ad angolo / Fixed panel for angle combination  
Paroi fixe pour combinaison en angle / Pared fija para combinación de esquina  
Vaste wand voor hoekcombinaties / Feste Wand für Kombinationen

H max 217 cm  
L min 30 cm max 110 cm

Larghezza - estensibilità Breadth - extensibility Largeur - extensibilité Composición - extensibilidad Breedte - aanpassingsvermogen Breite - Anpassungsfähigkeit	cod.	cod.	cod.	cod.
<b>L 68 - 70 cm</b>	B2590 F AN 01	B2590 F AN 14	B2590 F AN 73	B2590 F AN 41
WM - BM	B2590 F ..... 01	B2590 F ..... 14	B2590 F ..... 73	B2590 F ..... 41
AC - OR - BZ	B2590 F ..... 01	B2590 F ..... 14	B2590 F ..... 73	B2590 F ..... 41
<b>L 78 - 80 cm</b>	B2591 F AN 01	B2591 F AN 14	B2591 F AN 73	B2591 F AN 41
WM - BM	B2591 F ..... 01	B2591 F ..... 14	B2591 F ..... 73	B2591 F ..... 41
AC - OR - BZ	B2591 F ..... 01	B2591 F ..... 14	B2591 F ..... 73	B2591 F ..... 41
<b>L 88 - 90 cm</b>	B2592 F AN 01	B2592 F AN 14	B2592 F AN 73	B2592 F AN 41
WM - BM	B2592 F ..... 01	B2592 F ..... 14	B2592 F ..... 73	B2592 F ..... 41
AC - OR - BZ	B2592 F ..... 01	B2592 F ..... 14	B2592 F ..... 73	B2592 F ..... 41
<b>L 98 - 100 cm</b>	B2593 F AN 01	B2593 F AN 14	B2593 F AN 73	B2593 F AN 41
WM - BM	B2593 F ..... 01	B2593 F ..... 14	B2593 F ..... 73	B2593 F ..... 41
AC - OR - BZ	B2593 F ..... 01	B2593 F ..... 14	B2593 F ..... 73	B2593 F ..... 41

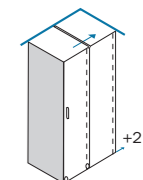

<p><b>Maniglie</b> Handles Poignées Tiradores Handvat Griff</p> <p>STANDARD</p>	<p>M3 ... AN BM WM</p>	<p>M3 ... AC OR BZ</p>	<p><b>Barra</b> Bar Barre Barra Staafl Leiste</p> <p>B0080A AN BM WM AC OR BZ</p>	<p>BKT251</p> <p>BKT251 CR BM WM AC OR BZ</p>	<p>BKT252</p> <p>BKT252 CR BM WM AC OR BZ</p>	<p><b>Kit chiusura magnetica</b> Magnetic closure kit Kit de fermeture magnétique Kit de cierre magnético Magnetische sluitingskit Magnetverschluss Set</p> <p>B0081 CR BM WM AC OR BZ</p>
---	------------------------	------------------------	---	---	---	--

# WALK IN\_COULISSANTE

Le dimensioni sono in mm / Sizes in mm /  
Les dimensions sont indiquées en mm /  
Las medidas son en mm /  
De afmetingen zijn vermeld in mm / Maßangaben in mm

